

OFERTA DE SEZON



Piese si accesorii pentru utilaje agricole | 11.02.2025 - 31.03.2025

NOU!

ANTIGEL ȘI LICHID DE PARBRIZ MARCĂ PROPRIE, LA PREȚURI AVANTAJOASE!





31,00



Lichid parbriz - de iarna, Easy Wipe Winter (-20°C), 4l

Solutie pentru curatarea parbrizelor si a altor suprafete de sticla, conferind acestora un aspect clar, stralucitor, fara urme si o mai buna vizibilitate in trafic atat ziua, cat si noaptea. Eficienta sporita pentru temperaturi de pana la -20°C.

Cod **AL1004R**



66,00



Antigel - G11+ Long Life concentrat (1:1=-38°C), 5kg (cca.4,5l)

Pe baza de monoetilenglicol, cu un sistem de aditivi hibrid silicati- HOAT. Nu contine nitriti, amine, fosfati. • ASTM D 6210 tip 1-FF • Case MS 1710; CNH MAT 3720; MAN 324 tip NF; MB 325.0/325.2; Volvo 128 6083/002; VW TL 774-C (G11)

Cod **AA1005C**



248,00



Antigel - G11+ Long Life concentrat (1:1=-38°C), 20kg (cca.18l)

Pe baza de monoetilenglicol, cu un sistem de aditivi hibrid silicati- HOAT. Nu contine nitriti, amine, fosfati. • ASTM D 6210 tip 1-FF • Case MS 1710; CNH MAT 3720; MAN 324 tip NF; MB 325.0/325.2; Volvo 128 6083/002; VW TL 774-C (G11)

Cod **AA1020C**



52,00



Antigel - G12+ Long Life ready-to-use (-37°C), 5kg (cca.4,5l)

Gata preparat, foarte stabil termochimic, ofera protectie la inghet de -37°C. • ASTM D3306/D4985 • Case MS 1710, John Deere JDM H24A1/H24B1/H24C1/H5, MAN 324 tip SNF, MB 325.0/325.2/325.3, Volvo 1286083, VW TL 774-A/B/C/D/F.

Cod **AA2005R**



191,00



Antigel - G12+ Long Life ready-to-use (-37°C), 20kg (cca.18l)

Gata preparat, foarte stabil termochimic, ofera protectie la inghet de -37°C. • ASTM D3306/D4985 • Case MS 1710, John Deere JDM H24A1/H24B1/H24C1/H5, MAN 324 tip SNF, MB 325.0/325.2/325.3, Volvo 1286083, VW TL 774-A/B/C/D/F.

Cod **AA2020R**



79,00



Antigel - G12++ Long Life concentrat (TL774G), 5kg (cca.4,5l)

Pe baza de monoetilenglicol este fabricat dupa o tehnologie "LOBRID". • ASTM D6210 Tip 1-FF • Case MS 1710, CNH MAT 3724, John Deere JDM H24A1/H24B1/H24C1/H5, MAN 324 tip Si-OAT, MB 325.5, Volvo 1286083, VW TL 774-G (G12++)

Cod **AA3005C**



294,00



Antigel - G12++ Long Life concentrat (TL774G), 20kg (cca.18l)

Pe baza de monoetilenglicol este fabricat dupa o tehnologie "LOBRID". • ASTM D6210 Tip 1-FF • Case MS 1710, CNH MAT 3724, John Deere JDM H24A1/H24B1/H24C1/H5, MAN 324 tip Si-OAT, MB 325.5, Volvo 1286083, VW TL 774-G (G12++)

Cod **AA3020C**



12,00

Apa distilata (demineralizata), 5l

Produs compatibil cu antigelul si electrolitii, utilizat pentru completare in baterii de pornire cu acid (cu electroliti) si pentru diluarea lichidelor antigel de racire motor si a lichidelor de parbriz. • Ambalaj: Bidon 5 l

Cod **AD1007**



107,00



Tester antigel - gefo glycomat 1100

Pentru toate amestecurile antigel-apa pe baza de etilenglicol/etandiol (G11, G12, G12+ si G12++). Robust si rezistent la spargere, cu un afisaj foarte precis care poate fi citit cu usurinta indiferent de temperatura lichidului de racire. Etansat cu supapa rotativa. Fara picurare si fara admisie de aer fals.

Cod **5001100**

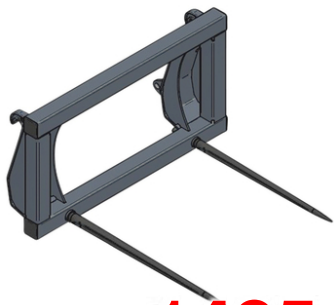

1485,00



Furca transport - baloti mari, 700kg

Furca de transport baloti pentru atasare la incarcatoare frontale cu suport de cadru cu interschimbare rapida, euro standardizat. Versiune grea, constructie robusta si stabil, calitate testata.

Cod 77875530



63,00



Sac mare Big-Bag - 900x900x1050, 1000kg, fara orificiu golire

Cod 5001015



479,00



Robinet golire - saci mari azot Big-Bag, cu tub flexibil

Dispozitiv robust si reutilizabil pentru golirea usoara si controlata a sacilor mari cu ajutorul unui glisor resigilabil. Potrivit pentru toate tipurile de materiale, precum seminte, ingrasaminte (azot), furaje etc. Materialul neutilizat ramane in sac, evitand risipa.

Cod 50099104



669,00



Cablu anti-inghet tevi - cu termostat, 230V, 768W, 48m

Protejeaza conductele de apa impotriva inghetului (pana la -40 °C cu izolatia suplimentara). Cablul este prevazut cu snur de racordare cu stecher, care este conectat cu supapa de incalzire prin intermediul unui termostat. Complet premontat.

Cod 580880499



148,00



Canistra carburant - 20l, plastic, militara, incl palnie flexibila

20 litri, atestare a Institutului Federal pentru Testare si Cercetare Materiale Lungime ?eava: 195 mm Ø-evacuare 20 mm Inaltime: 480 mm Specificatii: -Conducta de iesire se pastreaza in canistra -Cu conducta de iesire flexibila -Cu aerisire

Cod 50021127



636,00



Scaun tractor - susp. mecanica, PP

Scaun operator tractor cu suspensie mecanica, ecartament 187 mm si tapiserie din polipropilena (PP). • Ecartament: 187 mm • Tip suspensie: mecanica

Cod 24000061



36x

+

1x

1045,00



Pachet vaselina - Eni MP Grease si decalimetru

Pachetul include: • 36 x 172094 - Vaselina Eni MP Grease 380g • 1 x Decalimetru Speedy Grease system • Culoare: Negru • Ambalaj: Cartus 380 g • Consistenta: NLGI 2 • Specificatii: DIN 51825 : KP 2 K-20; ISO 12924 : L-X-BCHB 2

Cod 172194



762,00



Picior sprijin remorca - DG707W, 5440kg

Picior de sprijin pentru remorca, cu cric cu surub si manivela laterala, grunduit, cu reductor cu 2 viteze pentru operare cu pana la 70% mai rapida si 10% mai usoara.

Cod 220DG707W



132,00



Contor ore functionare - 12/24V, 52mm, analog

Contor ore de functionare 12/24 V, analog.

Cod 60799047



250,00



Taler disc - conic crestat, 520x5, 5gauri - Kverneland DTX, Qualidisc

Pentru adancitoare de brazda Kverneland DTX si grape cu discuri Kverneland Qualidisc. • Articol potrivit ptr: Kverneland

Cod 18034 RF3010497



166,00



Cupla mama - 100 / 4", L200, cu filet ext 4", sistem Berselli - vidanja / irigatii

Cupla rapida mama cu filet exterior, zincata la cald, pentru vidanje si sisteme de irigatii. • Articol potrivit ptr: Sistem italian (Berselli) • Versiune: cu filet • Diametru nominal: 100 mm; 4"

Cod 4050220589

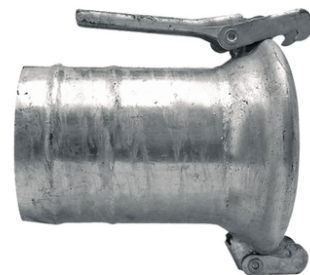

173,00



Cupla mama - 100 / 4", L208, cu stut D108, sistem Berselli - vidanja / irigatii

Cupla rapida mama cu stut pentru furtun, zincata la cald, pentru vidanje si sisteme de irigatii. • Articol potrivit ptr: Sistem italian (Berselli) • Versiune: cu stut • Diametru nominal: 100 mm; 4"

Cod 40504050989



8,00



Duza - cu jet plat, 110°, SW8, plastic, albastru

• Culoare: Albastru

Cod 670TP11003VP



8,00



Duza - cu jet plat, 110°, SW8, plastic, rosu

• Culoare: Rosu

Cod 670TP11004VP



8,00



Duza - cu jet plat, 110°, SW8, plastic, maro

• Culoare: Maro

Cod 670TP11005VP



239,00



Manometru - erbicidare, 25bar, 63mm, 1/4" axial

• Diametru cadran: 63 mm • Presiune max.: 25 bar

Cod 67001-00012



296,00



Manometru - erbicidare, 25bar, 100mm, 1/4" radial

• Diametru cadran: 100 mm • Presiune max.: 25 bar

Cod 67001-00014



80,00



Corp duza - 3 cai, pentru teava 3/4", 10mm, 12bar

Suport duza cu 3 cai de iesire, sistem prindere cu clema articulata si sistem antipicurare (supapa de retinere cu diafragma EPDM). • Versiune: Tri-Jet • Cai iesire: 3 • Diametru stut: 10 mm • Diametru teava: 19 mm

Cod 6704012757



Imagine asemănătoare

85,00

ARAG

Corp duza - 3 cai, pentru teava 1", 10mm, 12bar

Suport duza cu 3 cai de iesire, sistem prindere cu clema articulata si sistem anticupurare (supapa de retinere cu diafragma EPDM). • Versiune: Tri-Jet • Cai iesire: 3 • Diamentru stut: 10 mm • Diamentru teava: 25,4 mm

Cod 6704012767



Imagine asemănătoare

69,00

ARAG

Corp duza - 3 cai, pentru teava 1/2", 10mm, 20bar

Suport duza cu 3 cai de iesire, sistem prindere cu clema articulata si sistem anticupurare (supapa de retinere cu diafragma EPDM). • Versiune: Compact-Jet • Cai iesire: 3 • Diamentru stut: 10 mm • Diamentru teava: 12,7 mm

Cod 6704064247



Imagine asemănătoare

75,00

ARAG

Corp duza - 5 cai, pentru teava 3/4", 10mm, 20bar

Suport duza cu 3 cai de iesire, sistem prindere cu clema articulata si sistem anticupurare (supapa de retinere cu diafragma EPDM). • Versiune: Compact-Jet • Cai iesire: 5 • Diamentru stut: 10 mm • Diamentru teava: 19 mm

Cod 6704064957



Imagine asemănătoare

68,00

ARAG

Corp duza - 3 cai, pentru teava 3/4", 10mm, 20bar

Suport duza cu 3 cai de iesire, sistem prindere cu clema articulata si sistem anticupurare (supapa de retinere cu diafragma EPDM). • Versiune: Compact-Jet • Cai iesire: 3 • Diamentru stut: 10 mm • Diamentru teava: 19 mm

Cod 6704064257



Imagine asemănătoare

70,00

ARAG

Corp duza - 3 cai, pentru teava 20mm, 7mm, 20bar

Suport duza cu 3 cai de iesire, sistem prindere cu clema articulata si sistem anticupurare (supapa de retinere cu diafragma EPDM). • Versiune: Compact-Jet • Cai iesire: 3 • Diamentru stut: 7 mm • Diamentru teava: 20 mm

Cod 6704064227



Imagine asemănătoare

81,00

ARAG

Corp duza - 3 cai, pentru teava 20mm, 10mm, 20bar

Suport duza cu 3 cai de iesire, sistem prindere cu clema articulata si sistem anticupurare (supapa de retinere cu diafragma EPDM). • Versiune: Compact-Jet • Cai iesire: 3 • Diamentru stut: 10 mm • Diamentru teava: 20 mm

Cod 67040642271



Imagine asemănătoare

58,00

ARAG

Corp duza - 3 cai, pentru teava 25mm, 10mm, 20bar

Suport duza cu 3 cai de iesire, sistem prindere cu clema articulata si sistem anticupurare (supapa de retinere cu diafragma EPDM). • Versiune: Compact-Jet • Cai iesire: 3 • Diamentru stut: 10 mm • Diamentru teava: 25 mm

Cod 670406425A7



Imagine asemănătoare

107,00

ARAG

Corp duza - 5 cai, pentru teava 28mm, 10mm, 20bar

Suport duza cu 3 cai de iesire, sistem prindere cu clema articulata si sistem anticupurare (supapa de retinere cu diafragma Viton). • Versiune: Compact-Jet • Cai iesire: 5 • Diamentru stut: 10 mm • Diamentru teava: 28 mm

Cod 670406495B7



GRANIT
QUALITY PARTS

581,00

Alternator - 14V, 65A, (A), cu fulie dubla 93x2x9,7

Pentru tractoare si combine Fiat 80: 1880; 90: 90-90, 100-90, 110-90, 115-90, 130-90, 140-90, 160-90, 180-90; TK: 160-55; Winner F100: F 100, F 110, F 115, F 120, F 130, F 140 / Laverda 1000: 1740, 1950; 2000: 2050; 3000: 3300, 3400, 3500,

Cod 37897010



69,00



Claxon - 12V, 60W, ton jos

Claxon electromagnetice pentru tractoare Massey Ferguson s.a. • Articol potrivit ptr: Jungheinrich; Linde; Massey Ferguson; Still

Cod 50799053



195,00



Girofar - halogen, H1, 12V, prindere cu magnet

• Tip: H1 • Tensiune: 12 V

Cod 207RLM 94/12



101,00



Far lucru - LED, 12/24V

• Tensiune: 12 V; 24 V

Cod 12402349



92,00



Far lucru - halogen, H3, 12V, 55W, clar

• Articol potrivit ptr: Case IH; New Holland; Steyr • Tensiune: 12 V • Dimensiuni: 115x100 mm

Cod 70799007



19,00



Lampa spate - stg, 12V (stop, frana, semnalizare, placuta inmatriculare)

• Articol potrivit ptr: Massey Ferguson; Renault • Tip aplicatie: Tractor • Tensiune: 12 V • Pozitie montare: Spate; Stanga

Cod 70718022



238,00



Set 2x lampa spate - magnet, 7poli, 12V

• Nr. poli: 7 • Tensiune: 12 V • Pozitie montare: Stanga; Dreapta; Spate

Cod 70799033



245,00



Set 2x lampa spate remorca - 7poli, 12V

• Nr. poli: 7 • Tensiune: 12 V • Pozitie montare: Stanga; Dreapta; Spate

Cod 70799055



178,00



Traversa luminoasa

Cod 70799116



31,00



Stecher - plastic, 3poli, 12/24V (25A)

• Articol potrivit ptr: Massey Ferguson • Nr. poli: 3 • Tensiune: 12 V; 24 V

Cod 22725036200



60,00



Adaptor - plastic, 7/13 poli, 12V, ISO1724, ISO11446

• Nr. poli: 13; 7 • Tensiune: 12 V • Norma: ISO 11446; ISO 1724

Cod 50743945



40,00



Stecher - plastic, 13poli, 12V, ISO11446

• Nr. poli: 13 • Tensiune: 12 V • Norma: ISO 11446

Cod 50743920



91,00



Priza - plastic, 13poli, 12V, ISO11446

• Nr. poli: 13 • Tensiune: 12 V • Norma: ISO 11446

Cod 50743930



25,00



Stecher - plastic, 7poli, 6/12V, tip N, ISO1724

• Nr. poli: 7 • Tensiune: 12 V; 6 V • Norma: ISO 1724

Cod 50751305527066



24,00



Priza - plastic, 7poli, 6/12V, tip N, ISO1724

• Nr. poli: 7 • Tensiune: 12 V; 6 V • Norma: ISO 1724

Cod 50751305127066



51,00



Stecher - metal, 5poli, 24V, ISO1724

• Articol potrivit ptr: Case IH; Demag; Doll; Jungheinrich; Kogel; Liebherr; O & K; Schmitz Cargobull; Schwarzmuller; Terex • Nr. poli: 5 • Tensiune: 24 V • Norma: ISO 1724

Cod 4558JA 001916001



73,00



Priza - metal, 5poli, 24V, ISO1724

• Nr. poli: 5 • Tensiune: 24 V • Norma: ISO 1724

Cod 4558JB 001940001



58,00



Stecher - metal, 7poli, 12V, ISO1724

• Nr. poli: 7 • Tensiune: 12 V • Norma: ISO 1724

Cod 4558JA 001918011



61,00



Priza - metal, 7poli, 12V, tip N, ISO1724

• Nr. poli: 7 • Tensiune: 12 V • Norma: ISO 1724

Cod 4558JB 001941001



30,00



Pluviometru - 20cm, plastic transparent

Pluviometru din plastic transparent, cu suport pentru tija.

Cod 14700161

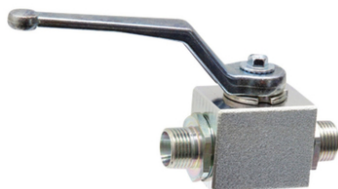

88,00



Robinet cu bila - 2 cai, BKH 2-10L DN8 (M16x1,5)

• Filet: M16

Cod 81520003



30,00



Cupla aer frana - mama, M16x1,5, capac galben

Pentru instalatie frana pneumatica cu 2 conducte. • Filet: M16

Cod 82770287



30,00



Cupla aer frana - mama, M16x1,5, capac rosu

Pentru instalatie frana pneumatica cu 2 conducte. • Filet: M16

Cod 82770289

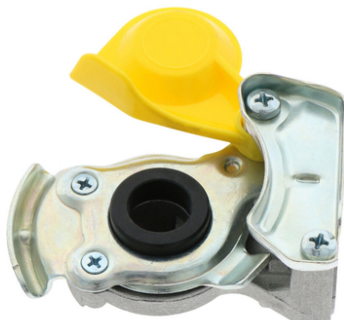

39,00



Cupla aer frana - mama, M22x1,5, capac galben

Pentru instalatie frana pneumatica cu 2 conducte. • Filet: M22

Cod 82770285



39,00



Cupla aer frana - mama, M22x1,5, capac rosu

Pentru instalatie frana pneumatica cu 2 conducte. • Filet: M22

Cod 82770288



51,00



Cupla aer frana - tata, M22x1,5, capac galben

Pentru instalatie frana pneumatica cu 2 conducte. • Filet: M22

Cod 82770291

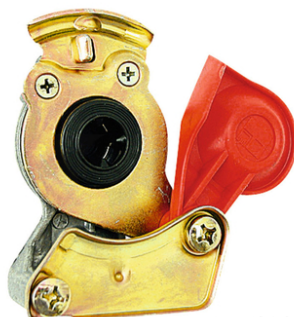

51,00



Cupla aer frana - tata, M22x1,5, capac rosu

Pentru instalatie frana pneumatica cu 2 conducte. • Filet: M22

Cod 82770292



301,00



Furtun umflare anvelope - 8m, incli manometru 10bar si cupla aer M16x1,5

• Filet: M16

Cod 8275-855408M



285,00

WABCO

Furtun spiralat - aer comprimat frana, TPU, rosu/rosu, M16x1,5 AG, 4m

• Filet: M16 • Norma: DIN 74323

Cod **8284527130010**



285,00

WABCO

Furtun spiralat - aer comprimat frana, TPU, galben/galben, M16x1,5 AG, 4m

• Filet: M16 • Norma: DIN 74323

Cod **8284527130020**



274,00

GRANIT
QUALITY PARTS

Arc - tractiune, 300N, 60x280x10, Zn - fixator protap remorca

• Diametru exterior: 60 mm • Lungime: 280 mm • Grosime: 10 mm

Cod **22060007**

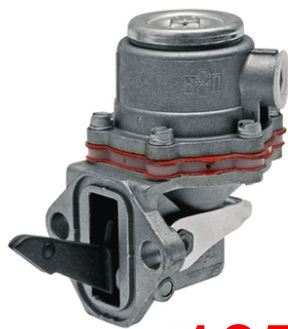

105,00

GRANIT
QUALITY PARTS

Pompa alimentare combustibil - Case IH / New Holland

• Articol potrivit ptr: Case IH; New Holland

Cod **38019486**



41,00

GRANIT
QUALITY PARTS

Pompa amorsare manuala combustibil, M16x1,5

• Articol potrivit ptr: Case IH; Deutz-Fahr; Fendt; Fiat; John Deere; Linde • Filet: M16

Cod **38054221016**



Imagine asamblat

366,00

BLUELINE

Arbore cardanic - B1, Lz560, 1 3/8" Z6, cruce 22x54,8

• Lungime: 560 mm

Cod **3770560B112**



Imagine asamblat

392,00

BLUELINE

Arbore cardanic - F21, Lz710, 1 3/8" Z6, cruce 22x54,8

• Lungime: 710 mm

Cod **377071021912**



Imagine asamblat

465,00

BLUELINE

Arbore cardanic - F22, Lz860, 1 3/8" Z6, cruce 24x61

• Lungime: 860 mm

Cod **377086022912**



755,00

BLUELINE

Arbore cardanic - B5, Lz1010, 1 3/8" Z6, cruce 30,2x79,4

• Lungime: 1010 mm

Cod **3771010B578**



67,00



Oglinda - stg/dr, 250x155, ptr tija 10-18mm - tractor Case / Fendt / Massey Ferguson

• Articol potrivit ptr: Case IH; Fendt; Massey Ferguson • Pozitie montare: Stanga; Dreapta

Cod 65402036



151,00



Oglinda - stg/dr, 298x219, ptr tija 18-22mm - tractor Fendt, John Deere, Kramer

• Articol potrivit ptr: Fendt; John Deere; Kramer; Wacker Neuson; Weidemann • Pozitie montare: Stanga; Dreapta

Cod 65412123



64,00



Oglinda - stg/dr, 260x160, ptr tija 10-12mm - Fritzmeier s.a.

• Articol potrivit ptr: Diversi producatori; Fritzmeier • Pozitie montare: Stanga; Dreapta

Cod 654RS260/160



90,00



Cap bara - stg/dr, 106mm, M18x1,5/M24x1,5, con 20-22

• Articol potrivit ptr: Case IH; Deutz-Fahr; Fiat; Ford; Hurlimann; John Deere; New Holland; Same; Steyr • Pozitie montare: Stanga; Dreapta; Fata

Cod 38710813



63,00



Deget dublu - heder combina Laverda (301896130)

Pentru hedere combina Laverda serie E (1/86-12/92) E310, E360, E390, E420, E480, E540, E600, E660, E760; serie MX E (1/86-12/90) MXE480, MXE540, MXE600, MXE660.

Cod 525301896130



51,00



Deget dublu - heder combina Case IH / New Holland (80379720)

Pentru hedere combina Case IH / Clayton / New Holland. • Articol potrivit ptr: Case IH; Clayton; New Holland • Tip aplicatie: Combina cereale; Heder

Cod 525379720



57,00



Deget dublu - heder combina John Deere (Z11228)

Pentru hedere combina John Deere. • Articol potrivit ptr: John Deere • Tip aplicatie: Combina cereale; Heder

Cod 525Z 11228



77,00



Deget dublu

Pentru hedere combina Deutz-Fahr / Dronningborg / John Deere / Laverda. • Articol potrivit ptr: Deutz-Fahr; Dronningborg; John Deere; Laverda • Tip aplicatie: Combina cereale; Heder

Cod 525616



54,00



Dinte rabator

• Articol potrivit ptr: Dronningborg; Laverda; Massey Ferguson • Tip aplicatie: Heder

Cod 52500548



30,00



Bucsa - deget escamotabil

Pentru hedere combina Case IH / Laverda / New Holland. • Articol potrivit ptr: Case IH; Laverda; New Holland • Tip aplicatie: Combina cereale; Heder

Cod 52580422654



10,00



Calota ghidaj - deget escamotabil

Pentru hedere combina Case IH / Laverda / New Holland. • Articol potrivit ptr: Case IH; Laverda; New Holland • Tip aplicatie: Combina cereale; Heder

Cod 52586632613



19,00



Maner (nuca) - volan, Ø28mm

• Diametru montare: 28 mm

Cod 20023190



173,00



Lama cutit (25buc) - heder Laverda

• Articol potrivit ptr: Laverda

Cod 525321219850/25



160,00



Lama cutit heder - grosiera, sist Schumacher (25buc)

Cod 525525207/25



1950,00



Umidometru cereale - Unimeter Super Digital XL

Masoara continutul de umiditate al multor boabe de cereale si seminte oleaginoase pe baza conductivitatii electrice a boabelor macinate intr-o rasnita incorporata. Dimensiunea mica a esantionului este potrivita pentru orice utilizare,

Cod 525525003

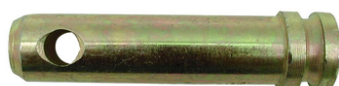

17,00



Bolt tirant central - cat.2, 25x76/91, Ø12mm

• Categorie: 2 • Diametru exterior: 25 mm • Lungime: 91 mm

Cod 20012805

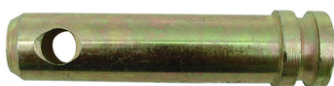

18,00



Bolt tirant central - cat.2, 25x110/125, Ø12mm

• Categorie: 2 • Diametru exterior: 25 mm • Lungime: 125 mm

Cod 20012810



23,00



Bolt tirant central - cat.2, 25x142/165, Ø12mm

• Categorie: 2 • Diametru exterior: 25 mm • Lungime: 165 mm

Cod 20012815



21,00



Bolt tirant central - cat.1, 19x135/151, Ø12mm, maner cu lant si splint

• Categorie: 1 • Diametru exterior: 19 mm • Lungime: 151 mm

Cod 20012851



18,00



Bolt tirant central - cat.2, 25x95/110, Ø12mm

• Categorie: 2 • Diametru exterior: 25 mm • Lungime: 110 mm

Cod 20012867



24,00



Bolt tirant lateral - cat.2, 28x135/151, Ø12mm, maner fara lant si splint

• Categorie: 2 • Diametru exterior: 28 mm • Lungime: 151 mm

Cod 20012880



38,00



Bolt tirant lateral - cat.2, 28x175/191, Ø12mm, maner cu lant si splint

• Categorie: 2 • Diametru exterior: 28 mm • Lungime: 191 mm

Cod 20012886



42,00



Bolt tirant lateral - cat.3, 37x135/151, Ø12mm, maner cu lant si splint

• Categorie: 3 • Diametru exterior: 37 mm • Lungime: 151 mm

Cod 20012901



61,00



Bolt tirant lateral - cat.3, 37x175/191, Ø12mm, maner cu lant si splint

• Categorie: 3 • Diametru exterior: 37 mm • Lungime: 191 mm

Cod 20012906



35,00



Bolt tirant lateral - cat.2, 28/28x149, filet M22x1,5, Ø12mm

• Categorie: 2 • Diametru exterior: 28 mm • Lungime: 149 mm • Filet: M22

Cod 20013005



38,00



Bolt tirant lateral - cat.2, 28/27x147, filet M27x1,5, Ø12mm

• Categorie: 2 • Diametru exterior: 28 mm • Lungime: 147 mm • Filet: M27

Cod 20013010



233,00



Set splinturi elastice

Cod 200999003



195,00



Set splinturi

Cod 200999005



450,00



Cupla remorcare - K50/D20, atasare in 3 puncte la tractor (cat.1, 508mm)

Acest dispozitiv este destinat pentru utilizare doar in afara drumurilor publice!

Cod 20020506



20,00



Bila tirant central - cat.1-2 (19x50x51)

• Categorie: 1-2 • Diametru exterior: 50 mm • Diametru interior: 19 mm • Latime: 51 mm

Cod 20012056



45,00



Bila tirant central - cat.4 (45x78x63)

• Categorie: 4 • Diametru exterior: 78 mm • Diametru interior: 45 mm • Latime: 63 mm

Cod 20099154



24,00



Bila tirant lateral - cat.1-2 (22x56x35)

• Categorie: 1-2 • Diametru exterior: 56 mm • Diametru interior: 22 mm • Latime: 35 mm

Cod 20011127



26,00



Bila tirant lateral - cat.3 (37x64x45)

• Categorie: 3 • Diametru exterior: 64 mm • Diametru interior: 37 mm • Latime: 45 mm

Cod 20011132



Imagine asemănătoare

54,00



Guler tirant lateral - cu bila, cat.3-2 (37x56), incl splint cu lant

• Categorie: 3-2 • Diametru exterior: 56 mm • Diametru interior: 37 mm

Cod 20011119



400,00



Carlig tirant lateral - cat.1, DN44, max.40kW/54CP

Cod 20088001



475,00



Carlig tirant lateral - cat.2L

Cod 20088002



178,00



Kit reparatie - carlig tirant lateral, cat.2L

Cod 20088021



237,00



Kit reparatie - carlig tirant lateral, cat.3

Cod 20088031



116,00



Tep incarcator frontal - L800, M22x2, drept, profil dublu T, cu piulita conica SW34

• Profil: Dublu T • Lungime: 800 mm • Filet: M22 • Forma: Drept

Cod 439439015



166,00



Tep incarcator frontal - L1000, M22x2, drept, profil dublu T, cu piulita conica SW34

• Profil: Dublu T • Lungime: 1000 mm • Filet: M22 • Forma: Drept

Cod 439439016



185,00



Tep incarcator frontal - L1100, M22x2, drept, profil dublu T, cu piulita conica SW34

Tepi pentru baloti mari • Articol potrivit ptr: Hauer; Schaffer; Weidemann • Profil: Dublu T • Lungime: 1100 mm • Filet: M22 • Forma: Drept

Cod 439439022



293,00



Pompa apa motor - tractor Case IH (mot. D239, D246, D268, DT239)

Info produs: include garnitura 74702015 Articol potrivit ptr: Case IH - Tipuri de tractoare: 353, 383, 423, 633, 733, 744, 833, 840, 940, 824, 744, 745S, 745, 844, 844S, 845, 743XL, 745XL, 844XL, 845XL, 856XL - Tipuri de motoare: D 239, D 246, D

Cod 74702002



350,00



Pompa apa motor - tractor Fiat

Articol potrivit pentru: Fiat - Tipuri de tractoare: 420, 300, 400, 474, 500, 600, 250, 350, 450, 550, 900, 1000, 440, 540, 640, 446, 466, 566, 666, 766, 470, 570, 670, 480, 880-5, 900, 980, 1000, 1180, 1280, 1380, 355, 455, 555, 460, 465, 765 - Tipuri de motoare: 8035.01, 8035.02, 8045.01, 8045.02,

Cod 74717000



66,00



Cruce cardanica - 27x74,6

• Lungime: 74,6 mm • Diametru pastila: 27 mm • Dimensiuni: 27 x 74,6 mm

Cod 377377016



43,00



Cruce cardanica - 22x54

• Lungime: 54 mm • Diametru pastila: 22 mm • Dimensiuni: 22x54 mm

Cod 377377014



47,00



Cruce cardanica - 24x61

• Lungime: 61 mm • Diametru pastila: 24 mm • Dimensiuni: 24x61 mm

Cod 377377015



65,00



Cruce cardanica - 27x70

• Lungime: 70 mm • Diametru pastila: 27 mm • Dimensiuni: 27 x 70 mm

Cod 377377055



81,00



Cruce cardanica - 30,2x79,4

• Lungime: 79,4 mm • Diametru pastila: 30,2 mm • Dimensiuni: 30,2x79,4 mm

Cod 377377056



65,00



Cruce cardanica - 30,2x91,5

• Lungime: 91,5 mm • Diametru pastila: 30,2 mm • Dimensiuni: 30,2x91,5 mm

Cod 377377057



184,00



Cruce cardanica - 36x89

• Lungime: 89 mm • Diametru pastila: 36 mm • Dimensiuni: 36x89 mm

Cod 377377061

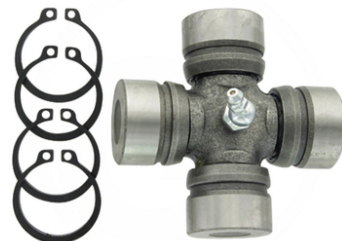

148,00



Cruce cardanica - 34x90

• Lungime: 90 mm • Diametru pastila: 34 mm • Dimensiuni: 34x90 mm

Cod 377377063



163,00



Cruce cardanica - 30,2x106,5

• Lungime: 106,5 mm • Diametru pastila: 30,2 mm • Dimensiuni: 30,2x106,5 mm

Cod 377377064



141,00



Cruce cardanica - 34,9x94

• Lungime: 94 mm • Diametru pastila: 34,9 mm • Dimensiuni: 34,9x94 mm

Cod 377377070



155,00



Cruce cardanica - 34,9x106

• Lungime: 106 mm • Diametru pastila: 34,9 mm • Dimensiuni: 34,9x106 mm

Cod 377377065



56,00



Aripa brazdar - stanga, 250x8

Pentru brazdar 450/480 mm pentru cultivatoare Kockerling / Kverneland / Rau / Sicam / Vogel & Noot. • Articol potrivit ptr: Kockerling; Kverneland; Rau; Sicam; Vogel & Noot • Pozitie montare: Stanga

Cod 56032 92537



56,00



Aripa brazdar - dreapta, 250x8

Pentru brazdar 450/480 mm pentru cultivatoare Kockerling / Kverneland / Rau / Sicam / Vogel & Noot. • Articol potrivit ptr: Kockerling; Kverneland; Rau; Sicam; Vogel & Noot • Pozitie montare: Dreapta

Cod 56032 92536



189,00



Dinte arc cultivator - 45x12, cpl cu brazdar

• Articol potrivit ptr: Saphir • Dimensiuni: 45x12 mm

Cod 1801.B242



78,00



Dinte arc cultivator - 32x10x550, cpl cu brazdar

• Articol potrivit ptr: Diversi producatori; BBG; Fortschritt; Kongskilde

Cod 23532 RS2977S



61,00



Arc intarire - 32x10

• Articol potrivit ptr: Amazone • Inaltime: 130 mm • Dimensiuni: 32x10 mm

Cod 1801.W241030-1



11,00



Brazdar cultivator - curbat, 35x6x195, 1-orificiu

• Articol potrivit ptr: Diversi producatori; Amazone; BBG ; Guttler; Horsch; Kongskilde; Lemken; Rabe; Stegsted; Unia

Cod 23532 RS2978S



2,00



Surub brazdar - cap oval, gat patrat, M10x40, cl8.8, cu piulita

Surub cu piulita pentru brazdar de cultivator si scormonitor urme pentru semanatori Accord / Amazone / Bednar / Kubota / Kverneland / Lemken / Rabe / Rau / Vicon ... • Articol potrivit ptr: Diversi producatori; Accord; Amazone; Bednar; Kubota;

Cod 23532 RS2977A



234,00



Sortiment saibe de cupru (inch), trusa 240buc

Sortiment inele de etansare din cupru in cutie de plastic, 240 bucati din 8 dimensiuni. • Continut: 1/4", 5/16", 3/8", 7/16", 1/2", 9/16", 5/8", 11/16" • Norma: DIN 7603

Cod 50099012



270,00



Sortiment saibe de cupru (mm), trusa 240buc

Sortiment inele de etansare din cupru in cutie de plastic, 240 bucati din 8 dimensiuni. • Continut: 6, 8, 10, 12, 14, 16, 18, 20 mm • Norma: DIN 7603

Cod 50099013



495,00



Compresor aer - priza putere tractor

Portabil, usor de atasat la tractor. Actionat de priza de putere a tractorului. Adecvat in special pentru umflare roti, curatare, suflare. Include furtun de cauciuc de 4 m, colier si niplu.

Cod 610AKS01



453,00



Set pistoale de suflat aer comprimat - 3piese, 95-510mm

• Lungime: 330 mm; 510 mm; 95 mm • Presiune max.: 6,3 bar

Cod 7885151921



205,00



Sortiment nipluri gresoare (inch), trusa 140buc

Continut: • 40x Niplu gresor drept 1/4" UNF • 10x Niplu gresor drept 5/16" UNF • 40x Niplu gresor drept 1/8" GAS • 20x Niplu gresor 90° 1/4" UNF • 10x Niplu gresor 90° 5/16" UNF • 20x Niplu gresor 90° 1/8" GAS • 1x cutie plastic compartimentata

Cod 50099018



14,00



Cupla gresare - 4 falci, M10x1, ptr furtun/teava decalimetru

• Filet: M10

Cod 50099040



36,00



Spray lant - 400ml

• Ambalaj: Spray 400 ml

Cod 320320006-2



85,00



Vopsea - verde Amazone, cutie 1l

Vopsea sintetica de calitate superioara cu aspect lucios, uscare rapida si acoperire exceptionala. • Articol potrivit ptr: Amazone • Culoare: Verde • Nuanta: Verde Amazone • Ambalaj: Cutie 1 l

Cod 27012014



85,00



Vopsea - portocaliu Amazone, cutie 1l

Vopsea sintetica de calitate superioara cu aspect lucios, uscare rapida si acoperire exceptionala. • Articol potrivit ptr: Amazone • Culoare: Portocaliu • Nuanta: Portocaliu Amazone • Ambalaj: Cutie 1 l

Cod 27012015



85,00



Vopsea - verde Claas, cutie 1l

Vopsea sintetica de calitate superioara cu aspect lucios, uscare rapida si acoperire exceptionala. • Articol potrivit ptr: Claas • Culoare: Verde • Nuanta: Verde Claas • Ambalaj: Cutie 1 l

Cod 27012046



85,00



Vopsea - rosu Guldner, cutie 1l

Vopsea sintetica de calitate superioara cu aspect lucios, uscare rapida si acoperire exceptionala. • Articol potrivit ptr: Guldner • Culoare: Rosu • Nuanta: Rosu Guldner • Ambalaj: Cutie 1 l

Cod 27012134



85,00



Vopsea - rosu Kverneland, cutie 1l

Vopsea sintetica de calitate superioara cu aspect lucios, uscare rapida si acoperire exceptionala. • Articol potrivit ptr: Kverneland • Culoare: Rosu • Nuanta: Rosu Kverneland • Ambalaj: Cutie 1 l

Cod 27012209



85,00



Vopsea - galben nou New Holland, cutie 1l

Vopsea sintetica de calitate superioara cu aspect lucios, uscare rapida si acoperire exceptionala. • Articol potrivit ptr: New Holland • Culoare: Galben •

Cod 27012263



56,00



Vopsea - portocaliu Amazone, spray 400ml

Vopsea acrilica de inalta calitate. • Articol potrivit ptr: Amazone • Culoare: Portocaliu • Nuanta: Portocaliu Amazone • Ambalaj: Spray 400 ml

Cod 27077008



56,00



Vopsea - verde Amazone, spray 400ml

Vopsea acrilica de inalta calitate. • Articol potrivit ptr: Amazone • Culoare: Verde • Nuanta: Verde Amazone • Ambalaj: Spray 400 ml

Cod 27077053



56,00



Vopsea - rosu Claas, spray 400ml

Vopsea acrilica de inalta calitate. • Articol potrivit ptr: Claas • Culoare: Rosu • Nuanta: Rosu Claas • Ambalaj: Spray 400 ml

Cod 27077003



56,00



Vopsea - verde bob Claas, spray 400ml

Vopsea acrilica de inalta calitate. • Articol potrivit ptr: Claas • Culoare: Verde • Nuanta: Verde bob Claas • Ambalaj: Spray 400 ml

Cod 27077054



56,00



Vopsea - verde nou 74 Deutz, spray 400ml

Vopsea acrilica de inalta calitate. • Articol potrivit ptr: Deutz • Culoare: Verde • Nuanta: Verde nou 74 Deutz • Ambalaj: Spray 400 ml

Cod 27077026



56,00



Vopsea - galben John Deere, spray 400ml

Vopsea acrilica de inalta calitate. • Articol potrivit ptr: John Deere • Culoare: Galben • Nuanta: Galben John Deere • Ambalaj: Spray 400 ml

Cod 27077047



56,00



Vopsea - albastru nou New Holland, spray 400ml

Vopsea acrilica de inalta calitate. • Articol potrivit ptr: New Holland • Culoare: Albastru • Nuanta: Albastru nou New Holland • Ambalaj: Spray 400 ml

Cod 27077050

SEDIU CENTRAL & PUNCT DE RIDICARE**ȘINDRILIȚA**

DN2, București - Urziceni km 20+600,
077104, Șindrilița, Com. Găneasa, Jud. Ilfov
Tel: 0744 974 441
E-mail: contact@eagropds.ro
www.eagropds.ro

**PUNCTE DE RIDICARE****ALEXANDRIA**

DN6, Tarla 20, Parcela 59,
140061, Alexandria, Jud. Teleorman

BOTOȘANI

DN29, Sat Hudum,
717113, Com. Curtești, Jud. Botoșani

BRĂILA

Șoseaua de centură, km 108,
810650, Brăila, Jud. Brăila

CAREI

Calea Mihai Viteazul, Nr. 121 A,
445100, Carei, Jud. Satu Mare

CĂLĂRAȘI

Str. Rocadei Nr. 50,
910053, Călărași, Jud. Călărași

CLUJ

Str. Libertății Nr. 7-15,
407035, Apahida, Jud. Cluj

CONSTANȚA

Str. Industrială Nr. 4,
905900, Ovidiu, Jud. Constanța

CRAIOVA

Calea București Nr. 148,
207450, Com. Pielești, Jud. Dolj

GIURGIU

Șos. Prieteniei Nr. 19,
080291, Giurgiu, Jud. Giurgiu

IAȘI

DN 28 Nr. 1115,
707280, Com. Lețcani, Jud. Iași

ORADEA

Str. Matei Corvin, Nr. 197,
410140, Oradea, Jud. Bihor

SLOBOZIA

Str. Călugăreni nr. 2A,
920050, Slobozia, Jud. Ialomița

TIMIȘOARA

Calea Lugojului Nr. 111,
307200, Ghiroda, Jud. Timiș

TULCEA

Str. Isacpei, Nr. 42-44,
820228, Jud. Tulcea

VASLUI

Str. Metalurgiei nr. 2,
730233, Jud. Vaslui